

ALESSANDROBATTAGLIA ARCHITETTO

made in the project

PERSONAL CAR
city car with SPD
FIAT ADUS
Milano, Italy, 2003



Auto & Design

PUBLICATION OF AUTO & DESIGN 141
LUGLIO/AGOSTO 2003 ANNO XXV N.4 ITALY

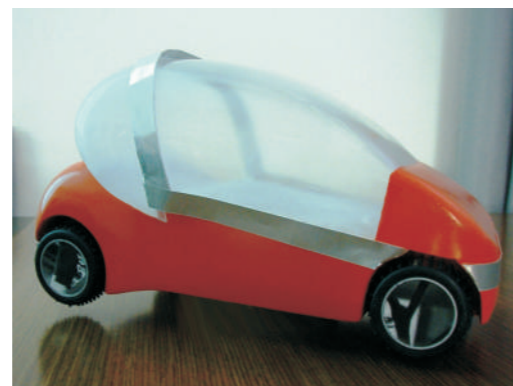
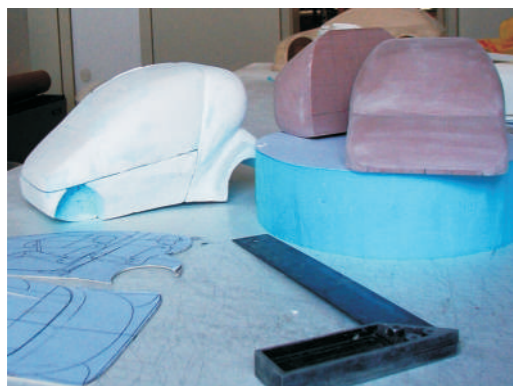
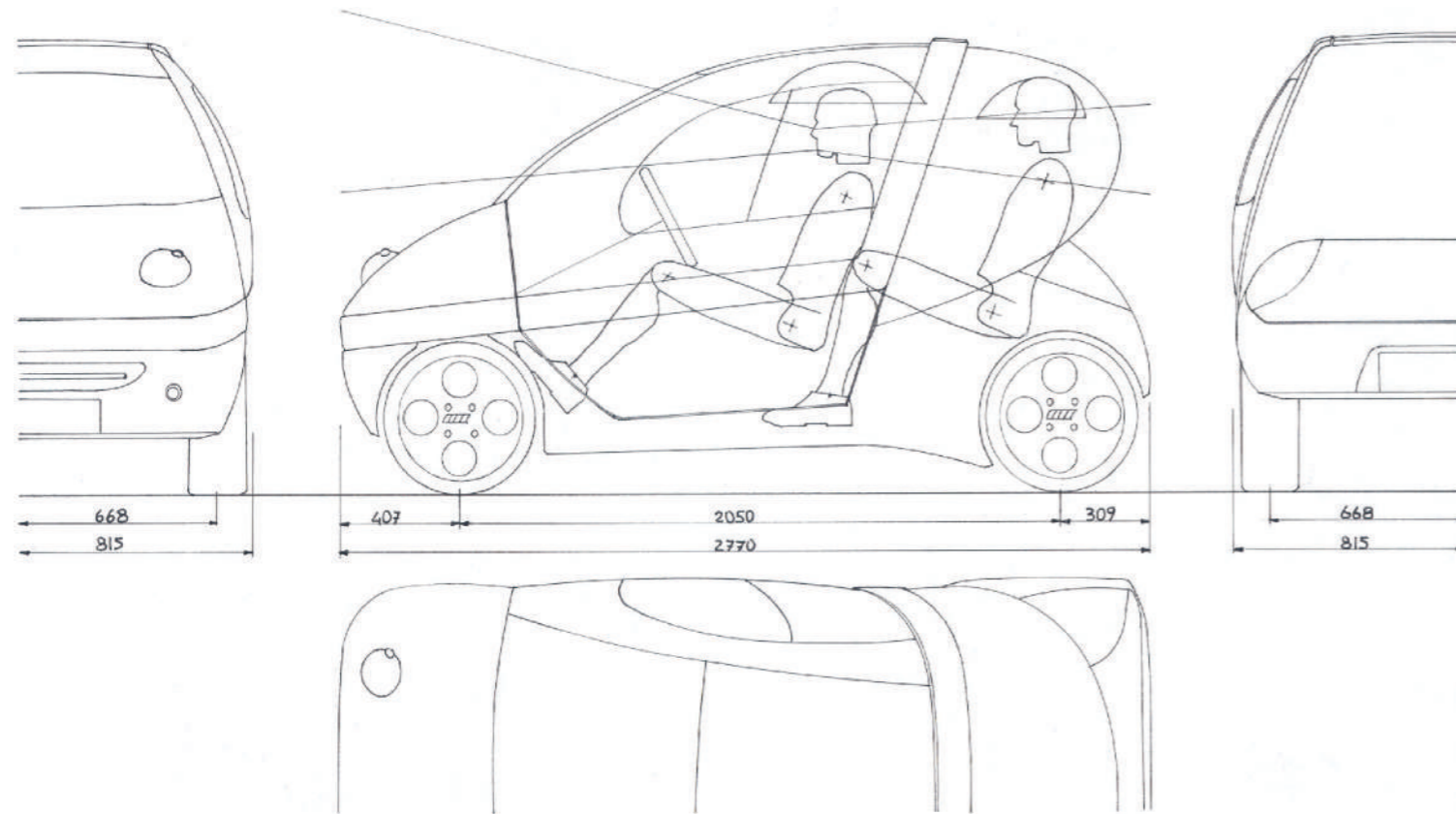
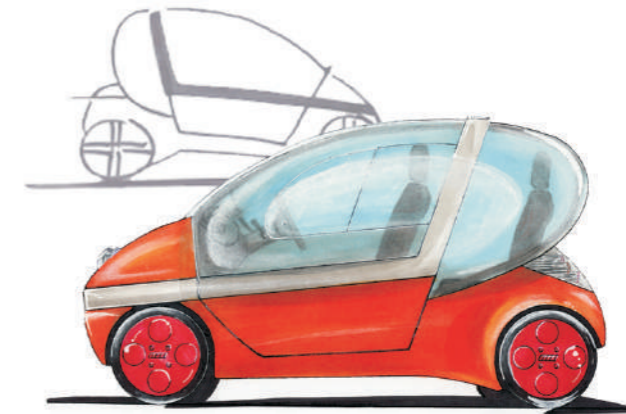

ALESSANDRO BATTAGLIA ARCHITETTO

TRILLO
tray design concept with Stefano Battaglia
Logos studio
Ragusa, Italy, 2004

Trillo

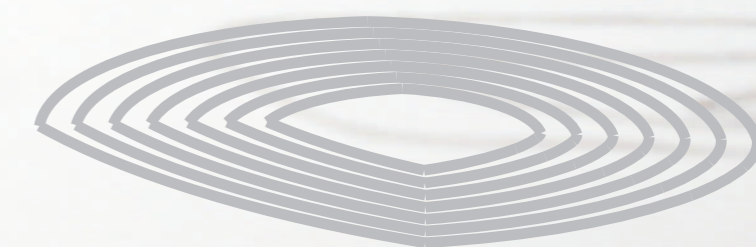
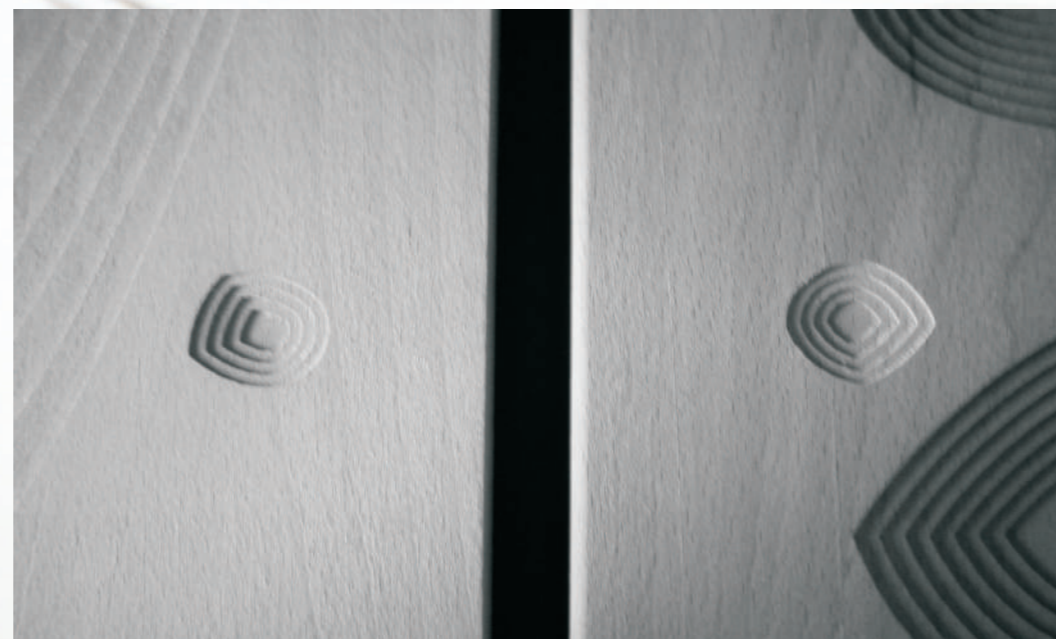
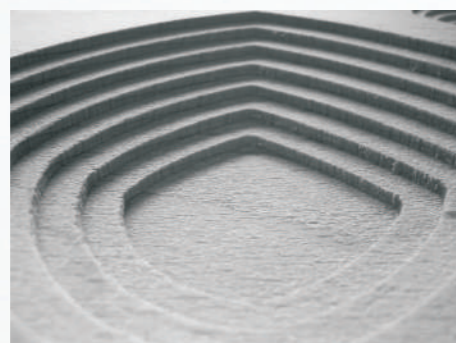
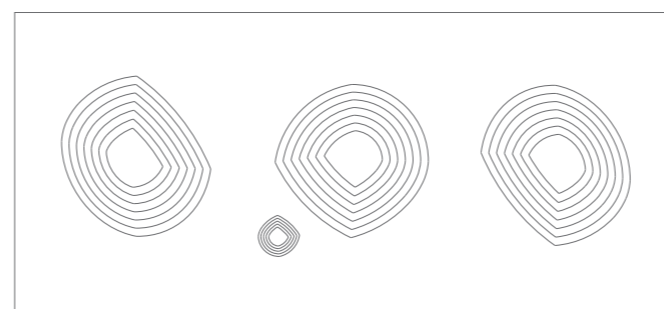
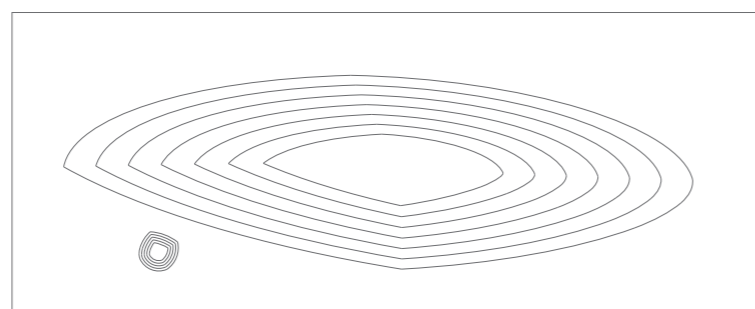
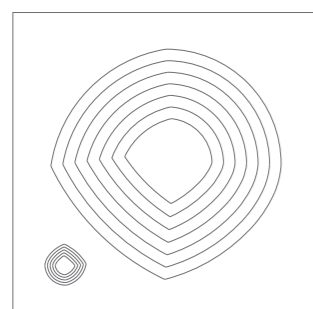

WATERFRONT COMPETITION
architectural design with Studio CAIROLI 102
project finance SEA Victoria House S.R.L.
Pozzallo, Ragusa, Italy, 2009

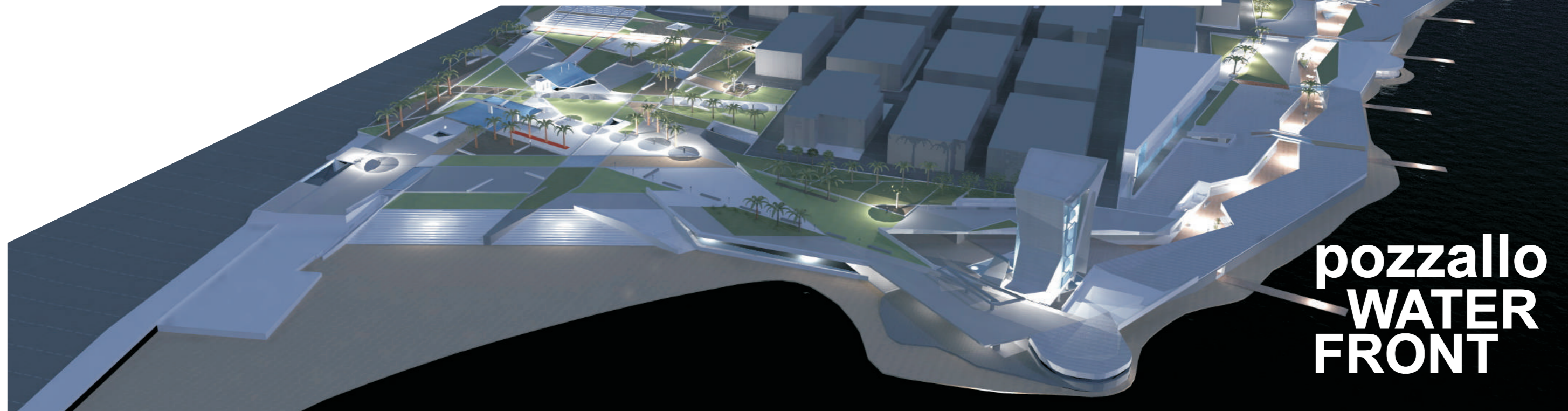
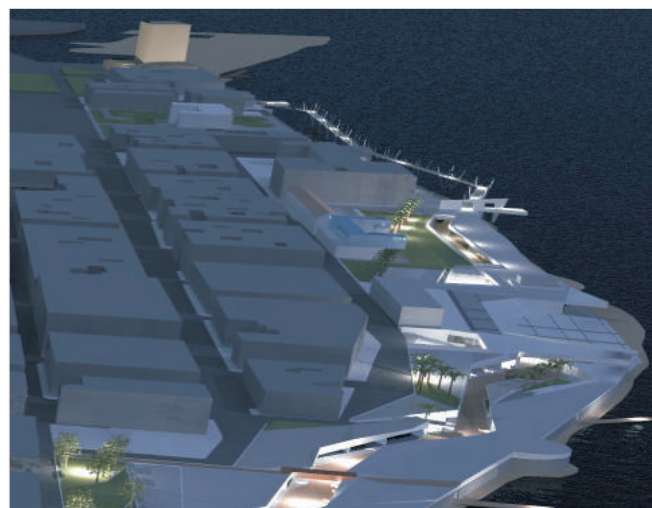
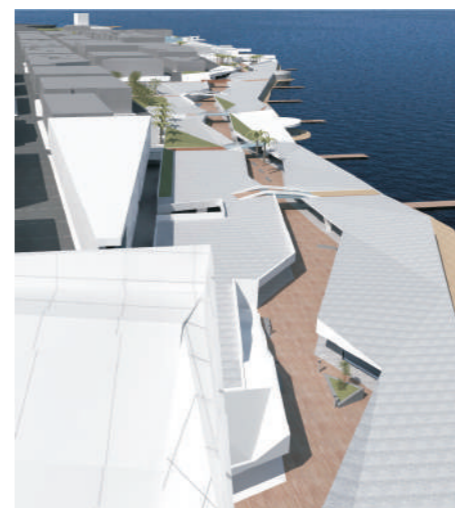
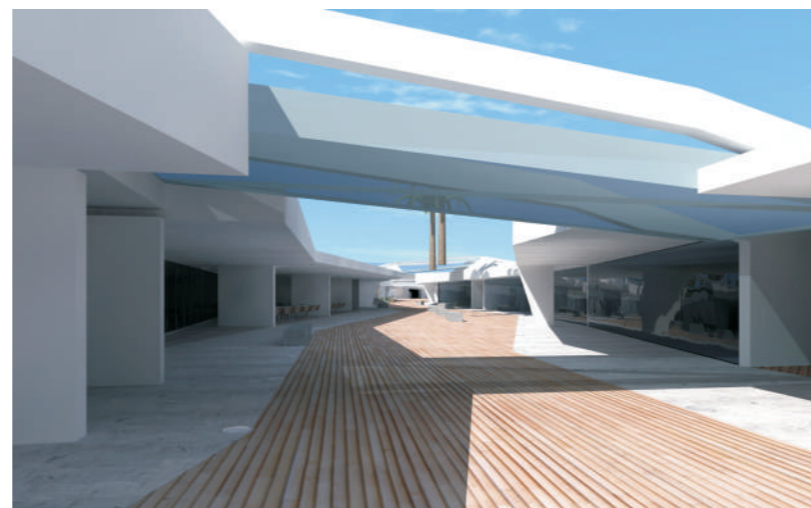
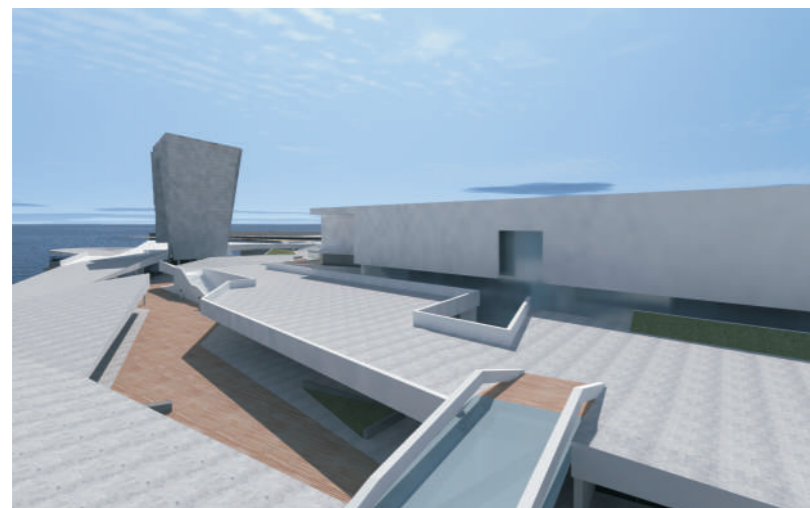

**pozzallo
WATER
FRONT**

RESTAURANT WINE BAR
 architecture design with Giuseppe Dimartino
 private
 Ragusa, Italy, 2009

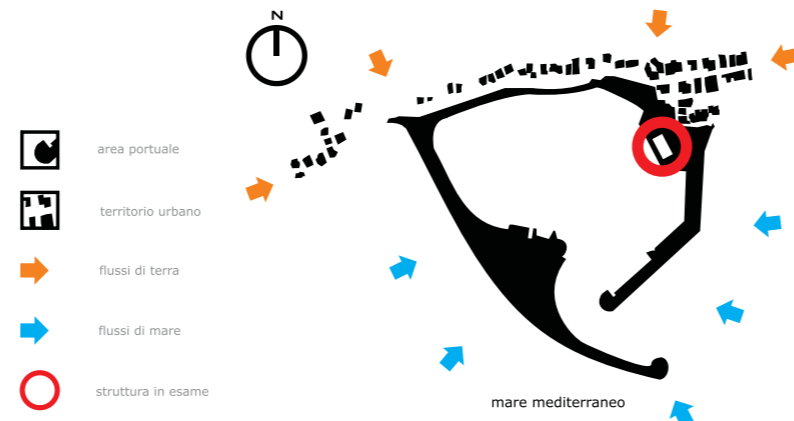

RESTAURANT WINE BAR
 Port of Marina di Ragusa

planimetria generale

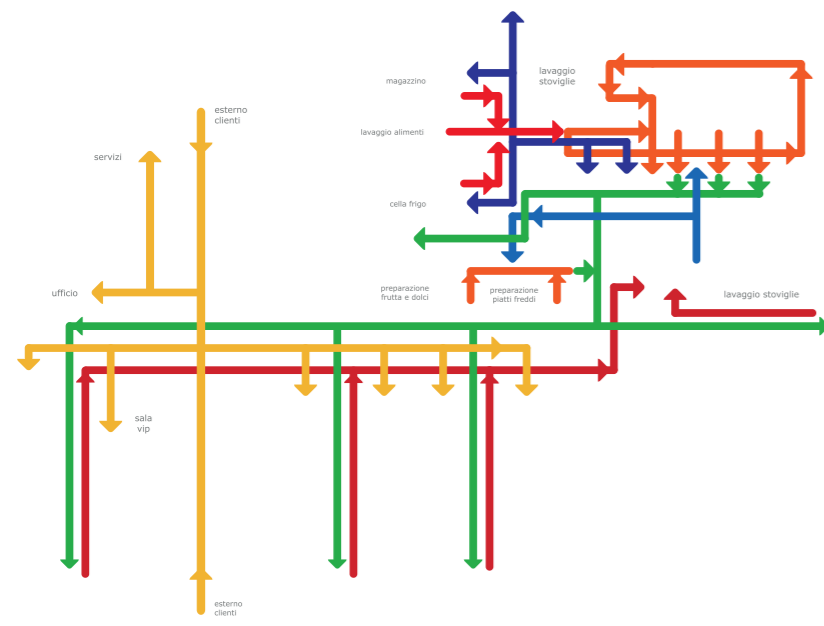

analisi dei flussi



veduta panoramica della struttura



fronte nord est



fronte nord est



fronte sud est



lounge bar

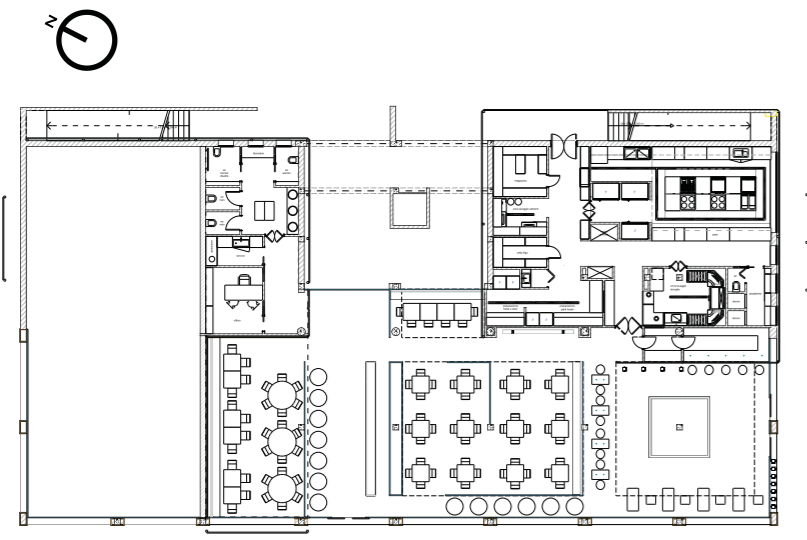

planimetria scala 1:200



sala ristoro



vista cantina e lounge bar



sala vip

TIBIDABO LOUNGE
interior and communication design with Illlgroup
society Tibidabo
Ragusa, Italy, 2010

tibidabo
lounge

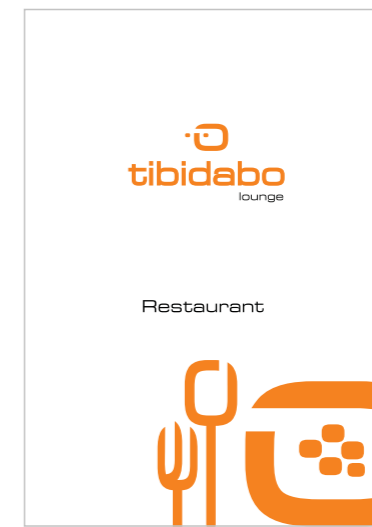

ALESSANDROBATTAGLIA ARCHITETTO

KONZA RESTAURANT
 interiors design and communication with Illlgroup
 New Dream S.N.C.
 Ragusa, Italy, 2011

KONZA

PIZZOLERIA PIZZERIA RISTORANTE

aceto finocchietto lenticcia strattu pinoli fassola ciciri
 tuono basilico arifunna sausizza patacchi diezza
 lassini maiurana puzza sararu
 ciappiri mazzarella rucola sardi
 spianacia cucuzza brusularenta
 patati sari pistacchia ancioru sari
 sciuridu pipi ardienti satariedu
 acciu agghia citralu

lienu carati puorri cipuda

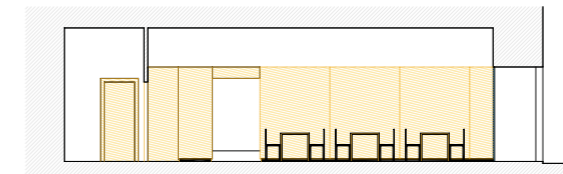
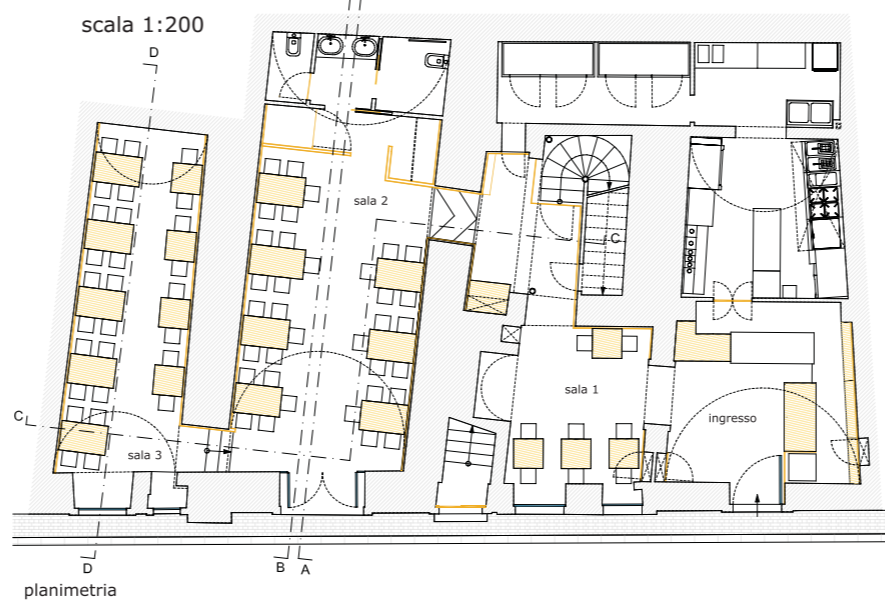
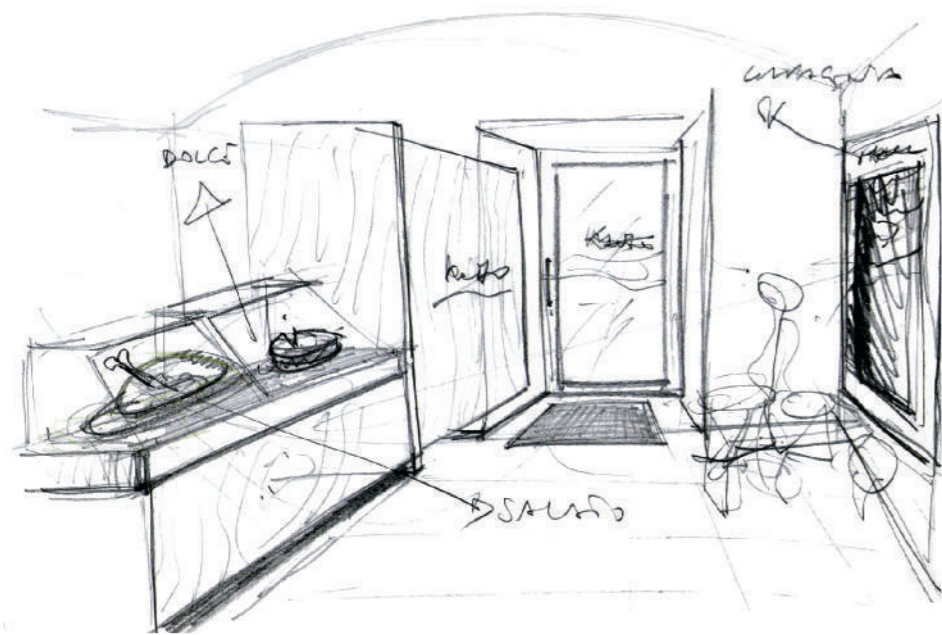

sezione A-A

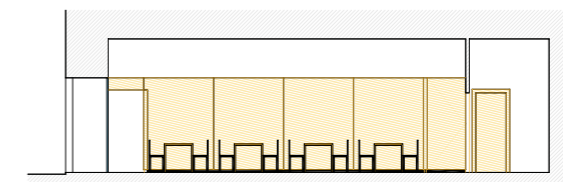

sezione B-B

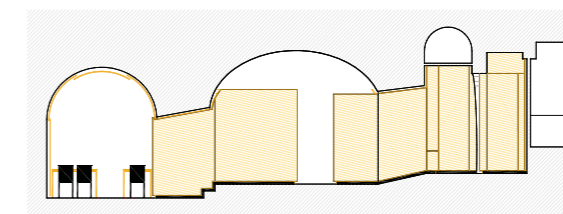

sezione C-C

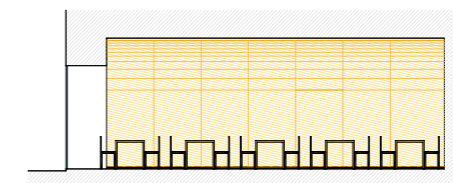

sezione D-D

PREMIO
 RAGUSA 2012
**ARCHI
 TET
 TURA
 OGGI!**
 REALIZZAZIONI
 E PROGETTI



ANCE RAGUSA



ALESSANDRO BATTAGLIA ARCHITETTO

KOKOFLEUR
egg cup design concept with Illlgroup
Grondal S.N.C.
Ragusa, Italy, 2012

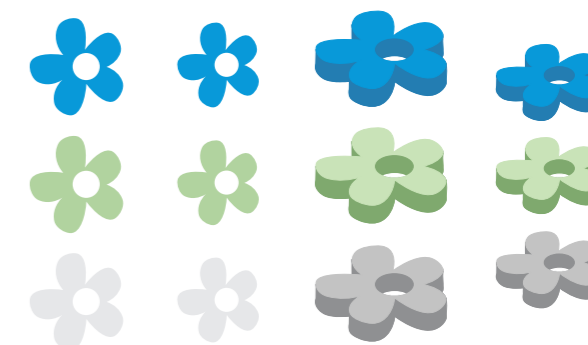
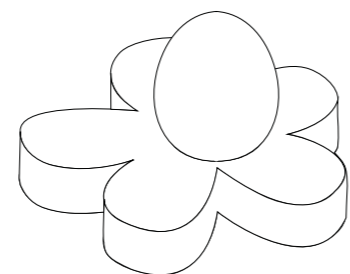
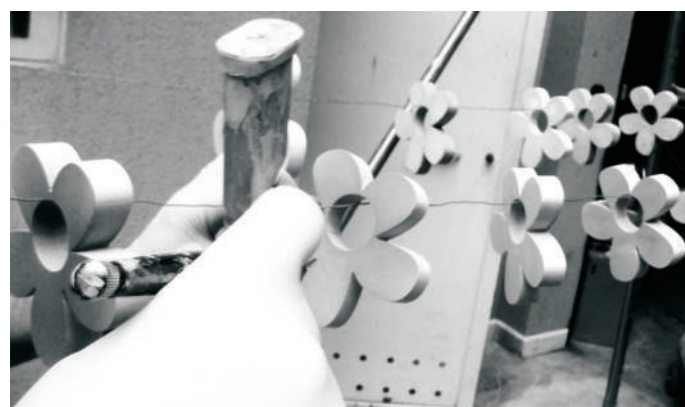
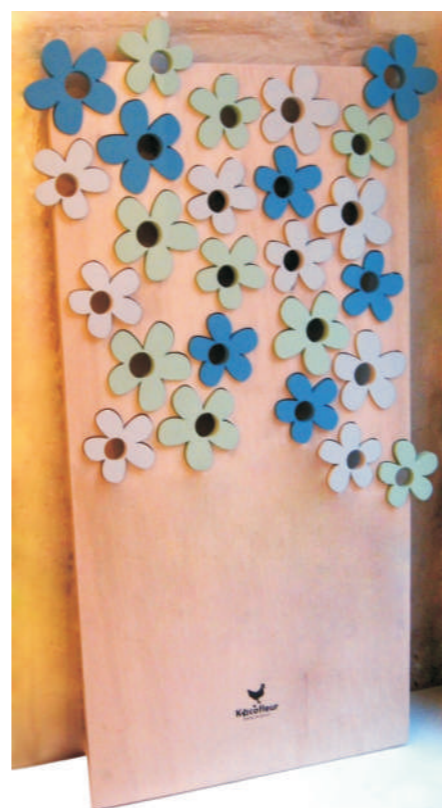
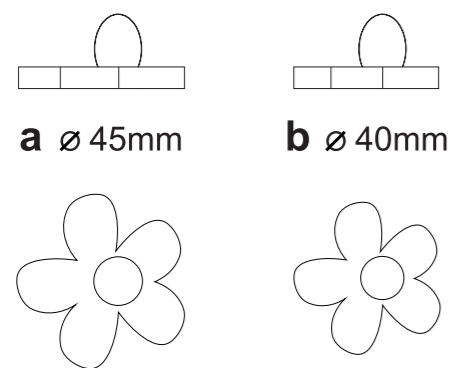
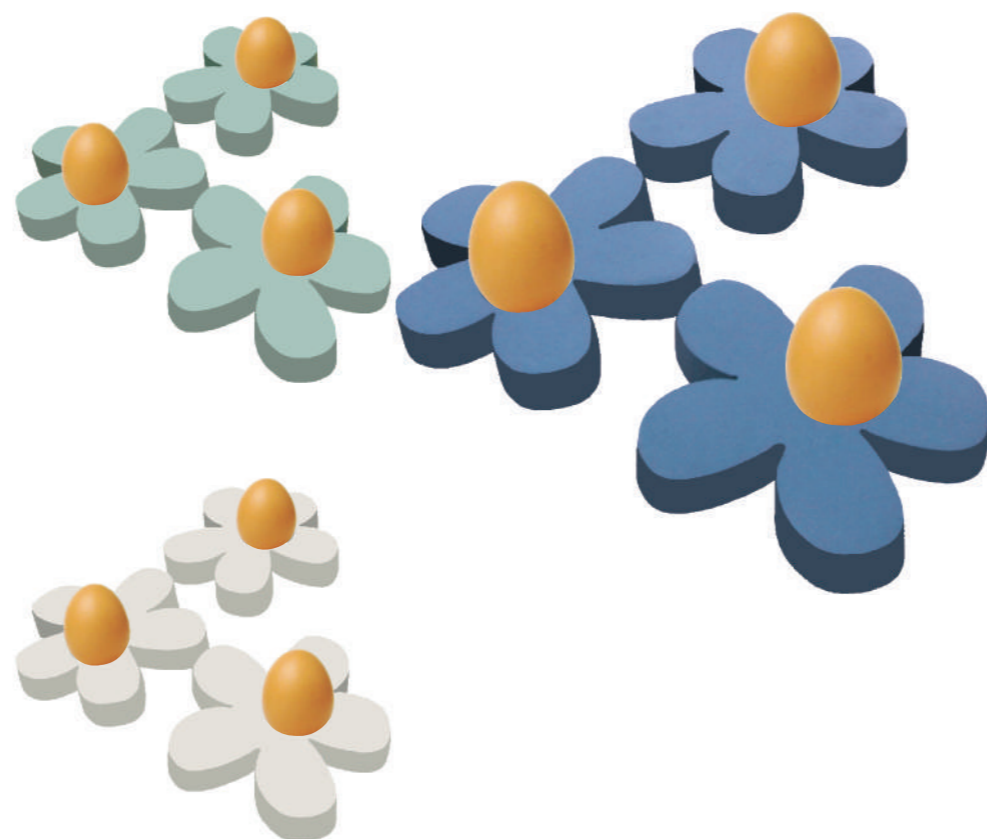

HORTUS CONCLUSUS
 competition of ideas by BLMS group
 GAL Terre di Murgia, Monastero del Soccorso
 Altamura, Italy, 2014

HORTUS CONCLUSUS



allestimento interno

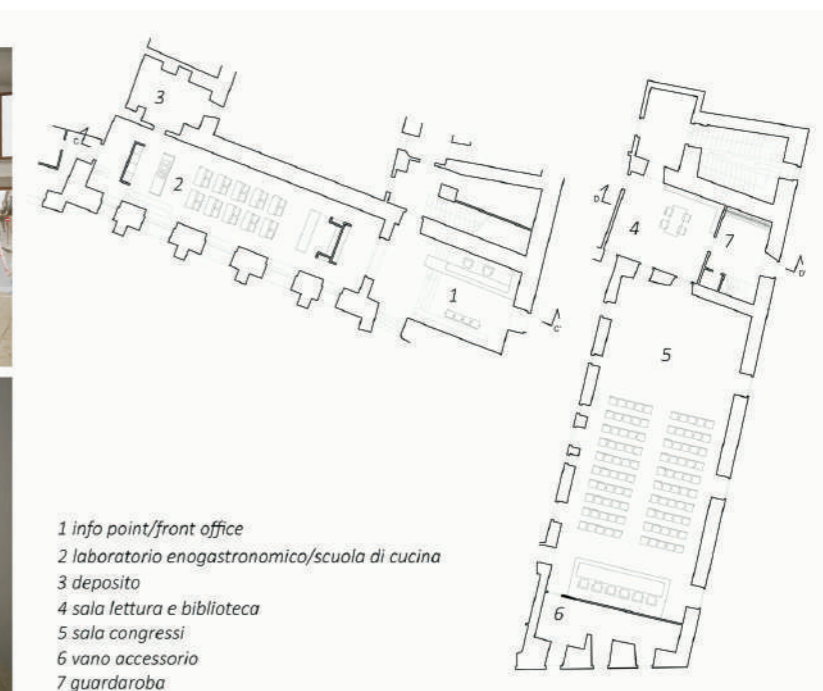

LA PICARA RESTAURANT
interiors design
La Picara S.R.L.
Casalmaggiore, Italy, 2015



LOFT
interiors design
private
Ragusa, Italy, 2017

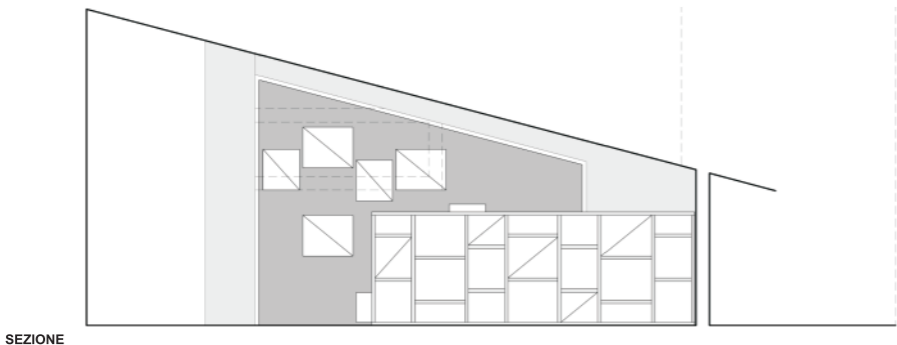

SEZIONE

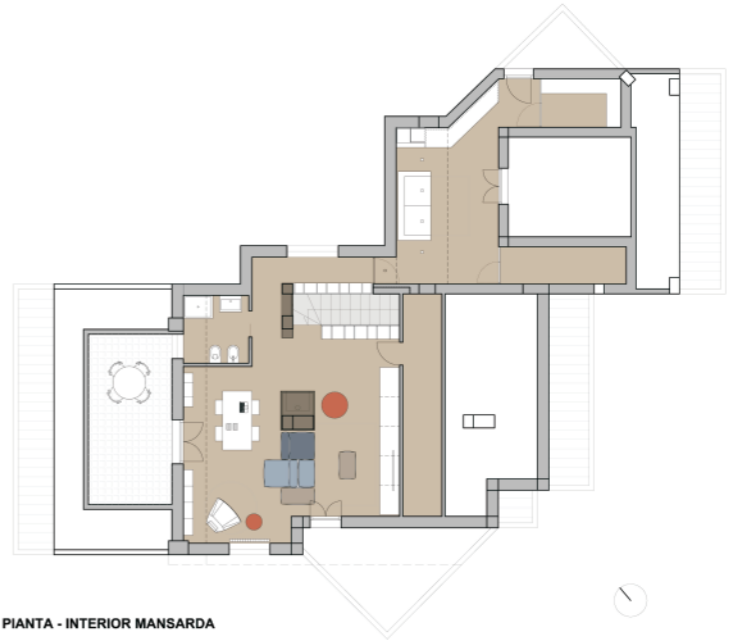

PIANTA - INTERIOR MANSARDA

ALESSANDROBATTAGLIA ARCHITETTO

VILLA CRISCIONE
architectural design
Villa Criscione S.R.L.
Ragusa, Italy, 2018

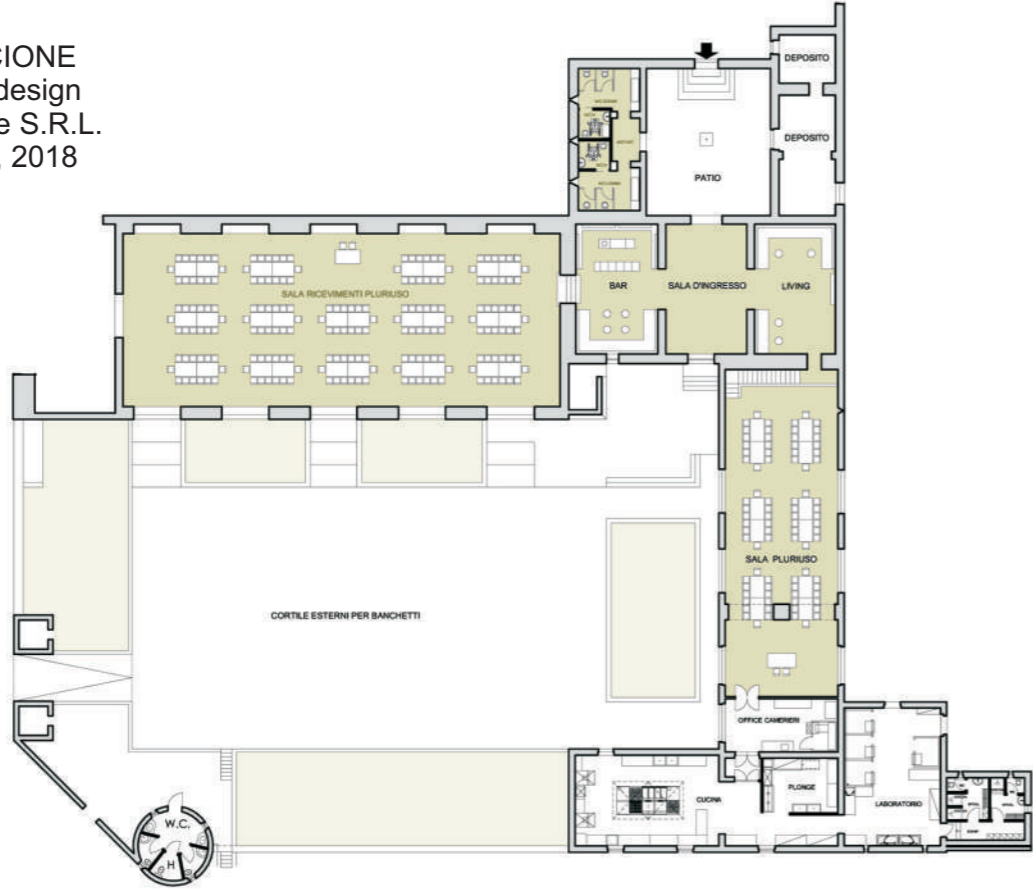

ALESSANDROBATTAGLIA ARCHITETTO

SANREMO HOUSE
architectural and interiors design
private
Marina di Ragusa, Italy, 2018



PIANTA PIANO I



PIANTA PIANO II

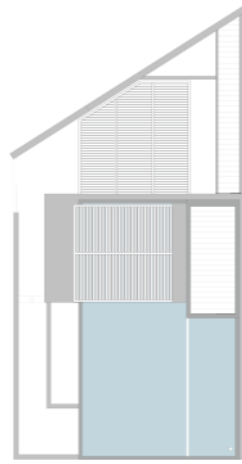

PIANTA PIANO TERRAZZA



ALESSANDROBATTAGLIA ARCHITETTO

ALESSANDROBATTAGLIA ARCHITETTO

329 9667239 alessandro.battaglia@alice.it